



**ONE  
PWR™  
SYSTEM**

**CORDLESS**

**EVOLVE PET**

**CORDLESS VACUUM**

**USER MANUAL**

**F18UVOP211**



# Welcome to HOOVER® ownership.

---

If you have any queries or concerns about using your Hoover cleaner:



Visit [hoover.com.au](http://hoover.com.au) or [hoover.co.nz](http://hoover.co.nz)

---

#### **DISTRIBUTED BY:**

Techtronic Industries Australia Pty Ltd  
31 Gilby Rd, Mount Waverley, VIC, 3149, Melbourne, Australia  
[www.hoover.com.au](http://www.hoover.com.au)

Techtronic Industries N.Z. Limited  
Unit C, 70 Business Parade South, Highbrook, Auckland,  
2013, New Zealand  
[www.hoover.co.nz](http://www.hoover.co.nz)

# Table of Contents

Safety Instructions .....	4
Battery Safety Instructions.....	5
Product Overview .....	6
Charging the Battery .....	7
Assembly Instructions.....	8
Operation.....	9
Emptying the Dirt Cup .....	10
Cleaning the Filter and Separator.....	11
Removing and Replacing the Brush Roll .....	12
Troubleshooting .....	13

# IMPORTANT SAFETY INSTRUCTIONS

## SAVE THESE INSTRUCTIONS

READ ALL SAFETY WARNINGS AND INSTRUCTIONS BEFORE USING THIS PRODUCT.

**WARNING:** When using an electrical product, basic precautions should always be followed to avoid electric shock, fire, and/or serious injury, including the following:

- Fully assemble product prior to use.
- Don't leave the charger plugged in when unattended.
- Don't use the machine if it is faulty or has been dropped, damaged or left outdoors.
- Don't use the machine to pick up any flammable or combustible materials (lighter fluid, petrol, kerosene etc.) or use the machine in an area with explosive vapours or liquid.
- Don't use the machine to pick up hot coals, cigarette butts, matches or smoking hot burning items or use in an area where there may be harmful fluids (chlorine, bleach and ammonia drain cleaner).
- Don't handle the charger, battery or use the machine with wet hands.
- Don't unplug the charger by pulling on the power cord.
- Don't use the charger if the power cord or plug is damaged.
- Don't attempt to remove blockages with sharp objects as this may cause damage to the machine.
- Don't use the machine with the incorrect battery or charger as this may result in damage or injury to the user. The correct battery charger information is listed on the battery pack ratings label.
- Don't charge the battery outdoors, or leave the charger connected to the mains when not in use.
- Don't use the machine with a damaged battery. If the battery is damaged return the machine, battery and charger to the point of purchase.
- Don't over fill the dirt container to avoid blocking the air flow through the machine.
- The brushbar in the powered head constantly rotates when switched on. Never use the powered head on one spot for an extended period of time as the brushbar may damage the floor surface.
- Only Hoover ONEPWR batteries and chargers should be used with this machine.
- Only Hoover ONEPWR recommended tools and accessories should be used with this machine.
- Always remove the battery from the machine before carrying out any maintenance or if storing unused for a long period of time.
- Keep all openings clear and free from debris as this may affect the airflow/suction.
- Keep all openings clear and free from debris as this may affect the airflow/suction.
- Turn off all controls on the machine before disconnecting or connecting the battery.
- Always protect the charger power cord from heated surfaces or near open flames.
- Only use the machine indoors on dry surfaces and keep the area you're cleaning well lit.
- This appliance is not intended for use by persons (including children) with reduced physical, sensory or mental capabilities, or lack of experience and knowledge, unless they have been given supervision or instruction concerning use of the appliance by a person responsible for their safety.
- Children should be supervised to ensure that they do not play with the appliance.
- Keep fingers, hair and loose clothing away from moving parts and openings whilst using the machine.
- Store the machine in a cool, dry area. Keep the machine away from rain and moisture.

- Take extra care when using the machine on the stairs.
- Use only Australian/New Zealand approved 10amp extension cords, non-approved extension cords may overheat. Care should be taken to arrange the extension cord as it can be a trip hazard.
- Always turn the powered head brushbar off when cleaning hard floors. To prevent any damage being sustained, test on an inconspicuous area of the flooring first.
- Always make sure the separator and filter are fitted correctly before using your machine and only use the machine with the filter and separator in place.
- Always check the powered head and accessories are free from damage, dirt and debris before using.
- This machine does not stay upright without constant support. Between uses, lie flat on the floor in a suitable location so that it does not become a trip hazard or can be stepped on.

## BATTERY SAFETY PRECAUTIONS

- Replace the battery with a Hoover ONEPWR battery only. Use of another battery may present a risk of fire or explosion.
- Do not attempt to disassemble the battery, remove any component projecting from the battery terminals and do not dispose of in a fire.
- The battery and charger have no user serviceable parts. Fire or injury may result.
- Prior to disposal, protect exposed terminals with heavy insulating tape to prevent shorting. The battery is to be disposed of safely at your local battery recycling centre.
- When the battery pack is not in use, keep it away from other metal objects that can make a connection from one terminal to another. Shorting the battery terminals together may cause burns or a fire.
- In case of battery leakages, avoid any contact with skin. Return the machine, battery and charger to the point of purchase.

## WARNING:

RISK OF FIRE, PROPERTY DAMAGE, AND INJURY. NEVER EXPOSE YOUR BATTERY PACK OR CHARGER TO WATER, MOISTURE, OR FLUIDS, INCLUDING BUT NOT LIMITED TO CORROSIVE OR CONDUCTIVE FLUIDS, OR ALLOW FLUIDS TO FLOW INSIDE THESE ITEMS. Corrosive or conductive fluids, such as salt water, chlorine, certain industrial chemicals, and bleach or bleach containing products, etc., can cause a short circuit in the battery pack. If your battery pack is exposed to a corrosive or conductive fluid, do not attempt to use or charge the battery pack and immediately perform the following steps:

- Wear appropriate personal protective equipment, including eye protection and rubber gloves.
- Place your exposed battery pack in a large bucket, and fill the bucket with regular tap water. Do not place more than two packs in the bucket.
- Locate the bucket outdoors in an area inaccessible to children and pets and away from all buildings, garages/sheds, structures, vehicles, and combustible/flammable materials.
- Leave the battery pack(s) in the bucket filled with tap water and contact Customer Service by visiting [hoover.com.au](http://hoover.com.au) / [hoover.co.nz](http://hoover.co.nz) or additional instructions on the proper disposal of the exposed battery pack(s).

# PRODUCT OVERVIEW

## MACHINE OVERVIEW

1. Comfort Grip Handle
2. Wand
3. ON/OFF Button
4. Mode Button & LED Mode Display
5. ONEPWR 4.0Ah Battery Pack
6. Filter/Separator Access
7. Easy Empty Dirt Cup
8. Dirt Cup Empty Button
9. Floor Head Hose Release
10. Removable Brushroll
11. ONEPWR Battery Charger

11

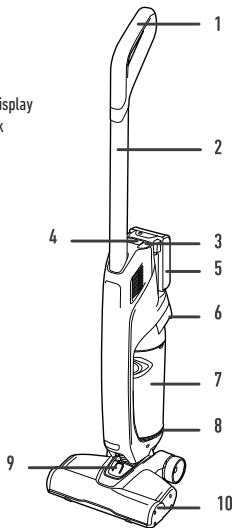

1. ON/OFF Button
2. Mode Button
3. LED Mode Display

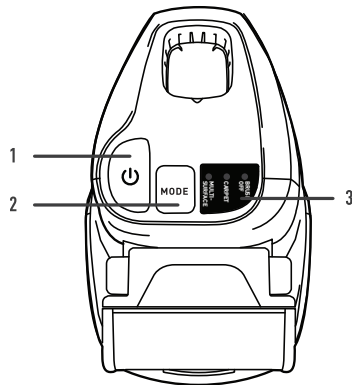

## SPECIFICATIONS

- Runtime: Up to 35mins
- Charge Time: 3.5 hours
- Dust Bin Capacity: 1.2L
- Product Weight: 3.3Kg
- Battery Voltage: 18V LI-ION

Runtime and charge time based on a 4.0Ah battery pack.  
Subject to technical change without notice.



# CHARGING THE BATTERY

**IMPORTANT:** This machine is only to be used with HOOVER ONEPWR batteries and chargers. Before first use, ensure the battery is fully charged.

1

Plug the charger into the power supply.

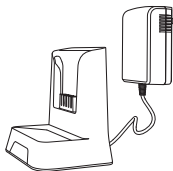

2

Slide the battery down on to the charger.



3

The charger light will flash white to show when the battery is charging. The light on the charger will stop flashing and go off when the battery is fully charged.



4

Once fully charged, slide the battery off the charger to remove.



To check the battery charge level press the battery symbol.



## TIPS

If the light on the charger flashes red, there is an error with the battery or the charger. Try again or contact Customer Service for support. During charging, the battery and ambient temperature should be between 5°C and 30°C. The charger will sense if the battery, or ambient temperature, is too cold or too hot, and will return an error code (red LED will be on) and not charge the battery.

# ASSEMBLY INSTRUCTIONS

FULLY ASSEMBLE PRODUCT PRIOR TO USE

**WARNING!** Ensure that the battery is removed from the charger before assembly, maintenance, or servicing.

1

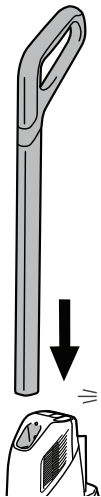

Install the wand into the body until it clicks into place.

2

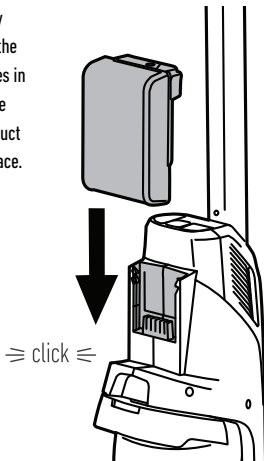

Attach the battery by aligning the ribs on the battery to the grooves in the product. Slide the battery into the product until it clicks into place.



# OPERATION

**CAUTION:** USE EXTRA CARE WHEN CLEANING ON STAIRS. TO AVOID PERSONAL INJURY OR DAMAGE, AND TO PREVENT THE CLEANER FROM FALLING, ALWAYS PLACE CLEANER AT BOTTOM OF STAIRS OR ON FLOOR. DO NOT PLACE CLEANER ON STAIRS OR FURNITURE, AS IT MAY RESULT IN INJURY OR DAMAGE.

**CAUTION:** NOT TO BE USED FOR GROOMING A PET.

1

Press the ON/OFF button located on the shoulder. The ON/OFF button and mode indicator lights will illuminate when ON.

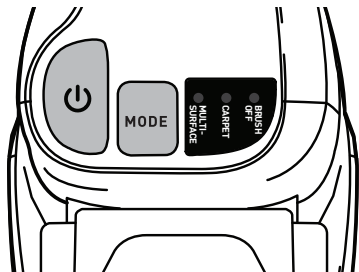

2

To change modes, press the Mode button on the shoulder. The mode indicators will illuminate, telling you which mode you are in.

- Evolve defaults to Multi-Surface Mode. This mode works well on all floor types and preserves runtime.
- Use Carpet Mode for deep cleaning on carpets with high suction.
- Use Brush Mode Off on delicate floor types. This mode has high suction with the brush roll off.

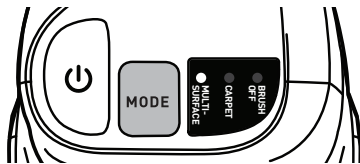

3

Step on the nozzle of the product and pull back handle to recline and begin cleaning.

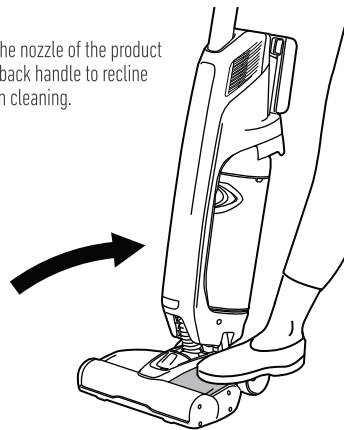

## EMPTYING THE DIRT CUP

**CAUTION:** DON'T OVER FILL THE DIRT CUP TO AVOID BLOCKING THE AIR FLOW THROUGH THE MACHINE. FOR BEST CLEANING RESULTS, EMPTY THE DIRT CONTAINER AFTER EVERY USE. ALWAYS REMOVE THE BATTERY BEFORE CARRYING OUT ANY MAINTENANCE OR TROUBLESHOOTING.

1

Remove the battery pack.

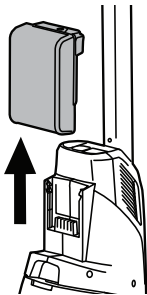

2

Push down the latch on the dirt cup to release. Rock the dirt cup backwards off the body.

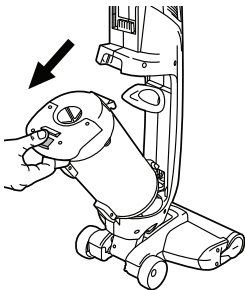

3

Hold the dirt cup over a trash bin and press the dirt cup release button to empty.

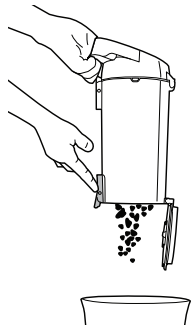

4

To close, push the door until it locks back into place.

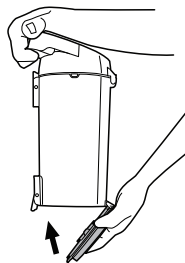

5

Replace the dirt cup by aligning the bottom first and then rocking it into place.

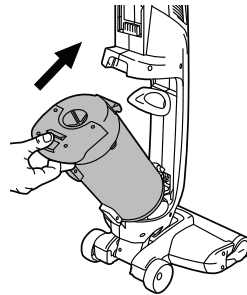

## CLEANING THE FILTER AND SEPARATOR

**CAUTION:** FILTERS SHOULD BE TAPPED OVER A BIN EVERY 4-6 USES TO REMOVE DIRT AND DEBRIS AND WASHED EVERY 3 MONTHS. FILTERS SHOULD BE REPLACED EVERY 6-9 MONTHS DEPENDING ON THE LEVEL OF USE. ALWAYS REMOVE THE BATTERY BEFORE CARRYING OUT ANY MAINTENANCE OR TROUBLESHOOTING.

1

Open the dirt cup lid to access the filter and separator.

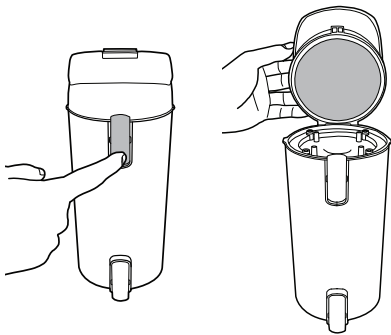

2

To clean the separator, lift to remove. Clean dirt and debris by wiping the metal screen with a cloth and then place back into the dirt cup.

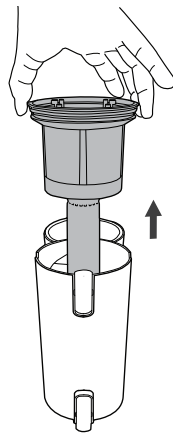

3

Pull the filter away and tap over a trash can to remove dirt. Rinse filter under warm water until water comes out clear. Allow filter to air dry for at least 24 hours until fully dry.

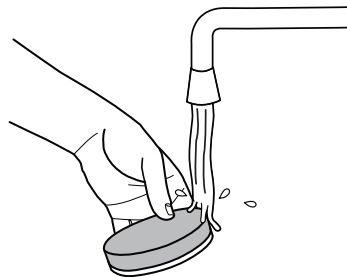

## REMOVING AND REPLACING THE BRUSH ROLL

**WARNING:** RISK OF PERSONAL INJURY - BRUSH ROLL MAY SUDDENLY RESTART. TURN POWER SWITCH OFF AND REMOVE BATTERY BEFORE CLEANING OR SERVICING.

1

Remove the battery. Using your fingers or a coin, push and turn the brush roll lock counterclockwise to release the brush roll.

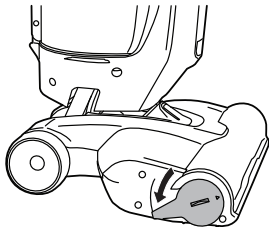

2

Pull the brush roll out of the nozzle with the pull tab.

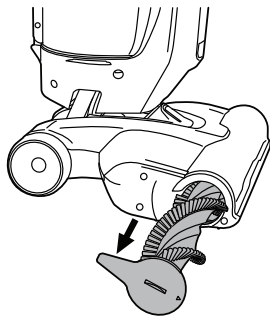

3

To remove any threads or hair, slide the blade of a pair of scissors into the groove of the brush roll and cut along the groove. Clear any dirt/debris from the end caps and inside the housing of the nozzle.

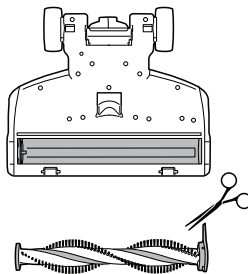

4

Re-fit the brush roll into the nozzle and turn the brush roll lock clockwise to lock.

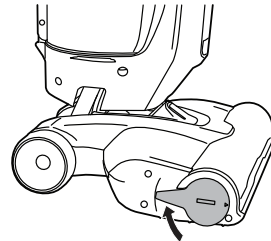

## TROUBLESHOOTING

**CAUTION:** TO REDUCE THE RISK OF PERSONAL INJURY, ALWAYS REMOVE THE BATTERY BEFORE CARRYING OUT ANY MAINTENANCE OR TROUBLESHOOTING.

### Why does the machine have no power?

- The battery is not fitted correctly. See 'Assembly Instructions'.
- The battery has no charge. See 'Charging the Battery'.
- The motor thermostat may have tripped. Empty the dirt container and check for blockages. Clean the filters and allow the machine to cool for approximately 1 hour. If you have washed the filters, wait 24 hours to fully dry before placing back on the machine. See 'Cleaning the Filter and Separator'.

### Why won't the machine pick up?

- The dirt cup may not be correctly fitted. See 'Emptying the Dirt Cup'.
- The dirt cup may be blocked. Check the dirt cup inlet for blockages. See 'Emptying the Dirt Cup'.
- The filters may be clogged. See 'Cleaning the Filter and Separator'.
- The powered head may be blocked. See 'Removing and Replacing the Brushroll'.
- The machine may not be assembled correctly. See 'Assembly Instructions'.

### Why is there a red light?

- Battery charge is running low (<20%). See 'Charging the Battery'.

### Why won't the brushbar turn?

- The tool/brushbar may be obstructed. See 'Removing and Replacing the Brushroll'.
- The machine may not be assembled correctly. See 'Assembly Instructions'.



®

HOOVER.COM.AU  
HOOVER.CO.NZ