

tineco

CARPET ONE PRO SERIES

Smart Carpet Cleaner

Instruction Manual



*Actual product may differ from illustration.

CONTENTS

Important Safety Instructions.....	2
Specifications	5
Overview.....	6
Accessories.....	7
Assembly	8
Operation.....	11
Maintenance	16
Troubleshooting.....	20
Warranty	21

Important Safety Instructions

SAVE THESE INSTRUCTIONS

Household use only.

When using an electrical appliance, basic precautions should always be followed, including the following:

READ ALL INSTRUCTIONS BEFORE USING (THIS APPLIANCE). Failure to follow the warnings and instructions may result in electric shock, fire and/or serious injury.

WARNING – To reduce the risk of fire, electric shock, or injury:

1. This appliance is not intended for use by persons (including children) with reduced physical, sensory or mental capabilities, or lack of experience and knowledge, unless they have been given supervision or instruction concerning use of the appliance by a person responsible for their safety.
2. Children should be supervised to ensure that they do not play with the appliance.
3. If the supply cord is damaged, it must be replaced by the manufacturer, its service agent or similarly qualified persons in order to avoid a hazard.
4. Use only indoors, do not immerse in liquid. To reduce risk of electric shock – Use only on carpet. Do not use on hard floors.
5. To reduce the risk of fire and electric shock – Use only Tineco cleaning products intended for use with this machine.
6. Use only as described in this manual. Use only manufacturer's recommended attachments.
7. CAUTION – Risk of injury. Brush may start unexpectedly. Unplug before cleaning or servicing.
8. Do not pull or carry by cord, use cord as a handle, close a door on cord, or pull cord around sharp edges or corners. Do not run appliance over cord. Keep cord away from heated surfaces.
9. Do not unplug by pulling on cord. To unplug, grasp the plug, not the cord.
10. Do not handle plug or appliance with wet hands.
11. Do not use with a damaged cord or plug. If appliance has been dropped, damaged, left outdoors, dropped into water, or is not working as it should, return it to a service center.
12. Do not put any object into openings. Do not use with any opening blocked; keep free of dust, lint, hair, and anything that may reduce air flow.
13. Keep hair, loose clothing, fingers, and all parts of your body away from openings and moving parts.
14. Use extra care when cleaning on stairs.
15. Do not use to pick up flammable or combustible liquids, such as gasoline, or use in areas where they may be present.
16. Do not pick up anything that is burning or smoking, such as cigarettes, matches, or hot ashes.
17. Do not use without filter.
18. To reduce the risk of electric shock, always install float before operation.

19. Prevent unintentional activation. Ensure the switch is in the off-position and unplugged from wall outlet before picking up or carrying the appliance.
20. Always switch off and unplug the appliance before making any adjustments, changing accessories, or storing the appliance. Such preventive safety measures reduce the risk of starting the appliance accidentally.
21. TO REDUCE THE RISK OF ELECTRIC SHOCK – UNPLUG BEFORE CLEANING OR SERVICING.
22. Turn off all controls before unplugging.
23. Do not leave appliance when plugged in. Unplug from outlet when not in use and before servicing.
24. Do not use to pick up ultrafine particles, such as lime, cement, sawdust, gypsum powder, or ashes.
25. Do not use to pick up sharp objects, such as metallic nails, pieces of glass, metal paper clips, or pins.
26. Do not use to pick up hazardous material and chemicals, such as solvent, drain cleaner, strong acids, or strong alkali.
27. Stop using immediately if the appliance is overheating, making unusual noises, producing unusual odors, performing low suction.
28. Turn cleaner OFF and disconnect from electrical outlet for storage.
29. Always clean the Dirty Water Tank after each use to avoid odour and potential blockage, which may lead to low suction power, motor overheating, or reduce the service life of the appliance.
30. Do not expose to rain.
31. Store appropriately indoors in a dry place after use.
32. Do not place or submerge appliance in standing water or try to clean flooded areas.
33. The plug must be removed from the socket-outlet before cleaning or maintaining the appliance.
34. To avoid hazard, do not run over power cord.
35. To reduce the risk of fire and electric shock due to internal component damage, use only Tineco cleaning fluid/solution: Carpet Deodorizing & Cleaning Solution intended for use with this appliance. See the Cleaning Fluid/Solution section of this manual.

Range of Usage

1. The Carpet washer is to be used on carpets, such as level loop, etc do not use on hard floors.
2. Keep your appliance away from heat sources, such as fireplace or heater, to avoid casing deformation.
3. Do not use to pick up flammable or combustible liquids, ultrafine particles, sharp objects, hazardous material, chemicals or anything that is burning or smoking, as described above.

About Cleaning Fluid/Solution





1. Do not shake the machine violently. Large amount of cleaning solution entering into the motor may cause damage to the appliance.
2. Add solution as instructed in the Operation section. We recommend using the provided cleaning solution.
3. Keep out of reach of children. If any solution gets into the eyes, immediately flush them with clean water. If any solution is swallowed by accident, seek medical care immediately.
4. Dirty water and solution disposal should comply with local environmental regulations.

About the Appliance

1. Do not modify or attempt to repair the appliance except as indicated in the instructions for operating and cleaning.
2. Use extra care when cleaning on stairs.
3. Ensure that the Power Switch is in the OFF-position and unplug before picking up or carrying the appliance. Do not lay flat or lean the appliance so as to prevent dirty water from entering into the motor.
4. Always install the Dirty Water Tank and Clean Water Tank properly before use.
5. Do not allow the appliance to get wet to avoid risk of fire or injury caused by a short circuit.



Symbols:

	Read the instruction manual
	For indoor use only
	Alternating current
	Power On/Off
	AUTO/MAX/DRY Mode

Specifications

Product	TINECO / CARPET ONE PRO SERIES
Voltage	220-240V~ 50Hz
Rated Power	~1300W
CWT Capacity	~2L
DWT Capacity	~1.5L
Waterproof	IPX4
WiFi Frequency Bands	2.4G
WiFi Maximum Output Power	19dBm

- All data and technical instructions of this manual are based on results from lab tests of Tineco or designated third parties. The company reserves all rights for final explanations.

Overview

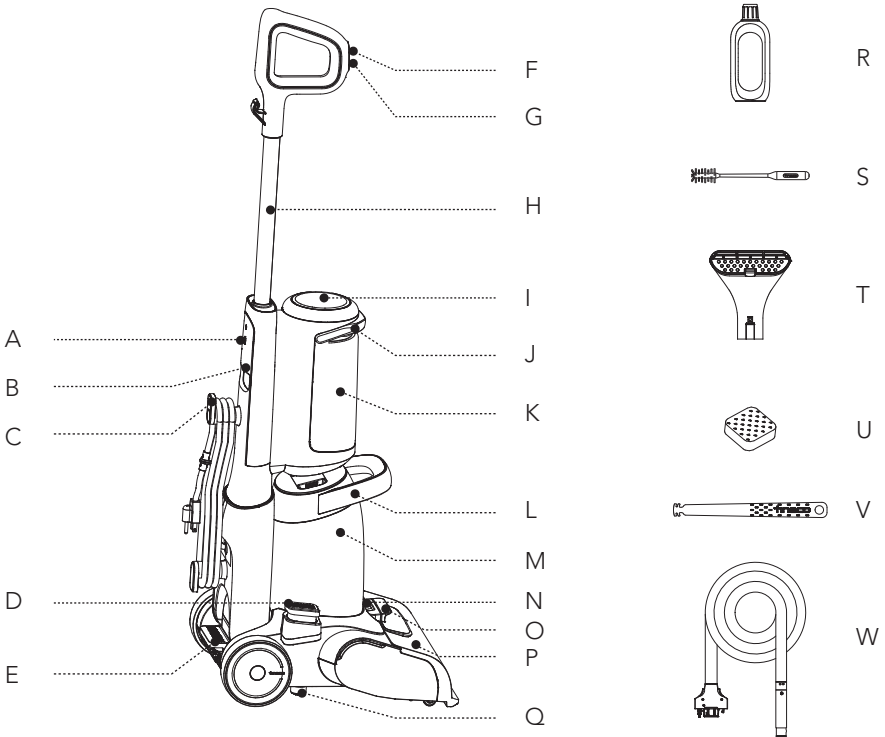

- A. WiFi/Mute/Language Switch Button
- B. Back Carry Handle
- C. Cord Wrap
- D. Dirty Water Tank Release Pedal
- E. Recline Pedal
- F. AUTO/MAX/DRY Mode
- G. Power On/Off
- H. Tube
- I. Digital Display
- J. Clean Water Tank Handle
- K. Clean Water Tank (CWT)
- L. Dirty Water Tank Handle
- M. Dirty Water Tank (DWT)
- N. Brush Roller Cover Release Button
- O. Hose Connection Port Cover
- P. Brush Roller Cover
- Q. Humidity Sensor
- R. Carpet Deodorizing & Cleaning Solution
- S. Cleaning Tool
- T. 2 in 1 Nozzle
- U. Sponge Filter
- V. Brush Cover Scraper
- W. Accessory Hose

Accessories

Note:

Accessories may vary between markets. If you would like to purchase accessories or consumables, please contact Customer Service on **AUS: 1800 815 270, NZ: 0800 282 288**.

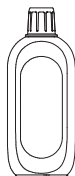

Carpet Deodorizing & Cleaning Solution

Removes dirt, grime, grease and tough stains from most types of carpets.

Always use Tineco solution in your appliance.

Add two bottle caps of solution to each full tank of clean water.

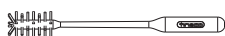

Cleaning Tool

A full brush to clean the DWT, brush chamber and opening.

The tool also has a bristled end to remove dirt and mud on the roller and DWT.

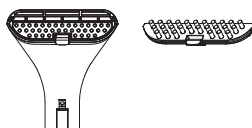

2 in 1 Nozzel

Remove tough stains on the carpet.



Sponge Filter

Sponge filter can block large particles and debris, ensure the appliance's durability.

* Please install the Sponge filter before use, or it may lead to weak suction.



Brush Cover Scraper

A scraper to clean the brush cover gap.

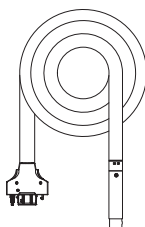

Accessory Hose

A 2.5-meter hose to connect the appliance and accessory brushes.

Assembly

How to Assemble/Disassemble

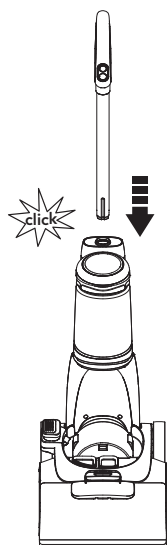

To assemble the handle, insert it into the appliance until you hear a click.

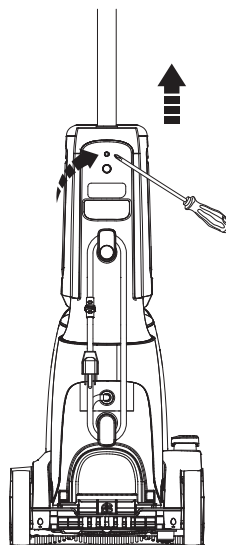

In the event that the handle need to be disassembled, press the spring to release the handle with a tool (like a screwdriver) and lift the released handle from the appliance.

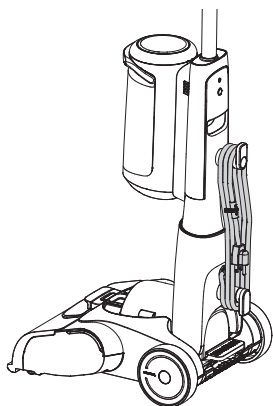

Wrap the power cord around the cord hooks for convenient storage.

Clean Water Tank

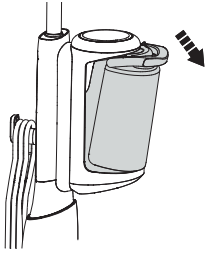

Press the CWT handle to remove it.

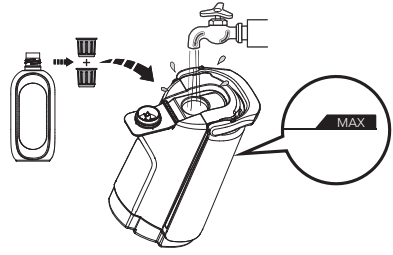

Open the tank cap, add two bottle caps of solution to the CWT then fill with tap water to the Max line and tightly close the cap.

Note:

Only use water under 140°F/60°C.
DO NOT USE HOT WATER.

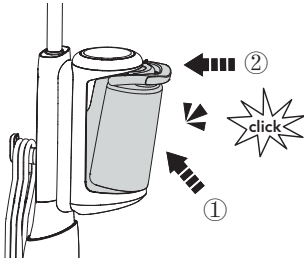

Install the Clean Water Tank into the appliance.
You should hear a "Click" if done correctly.

Dirty Water Tank

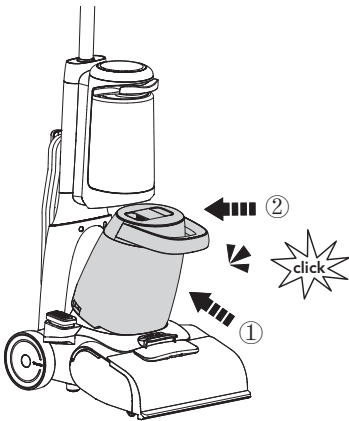

Install the Dirty Water Tank into the appliance.
You should hear a "Click" if done correctly.

Accessory Hose & 2 in 1 Nozzle

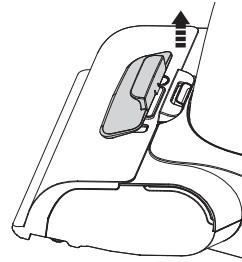
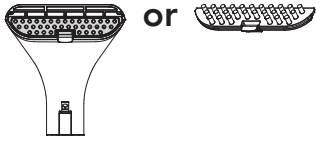

Choose suitable brush head according to the usage scenario.

Pull it up to uncover the accessory connection port.

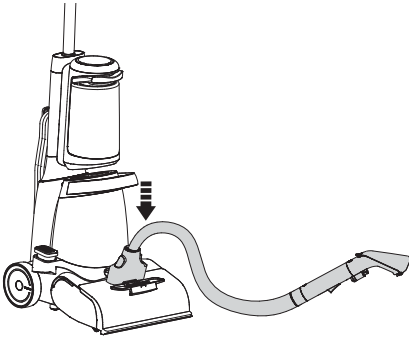

Insert the hose end into the port.
You should hear two "Clicks" if done correctly.

Operation

Preparing for Use (Appliance)

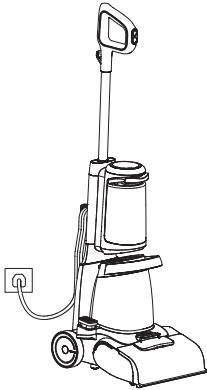

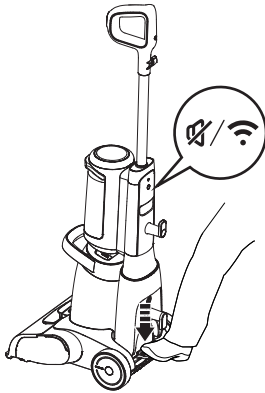

Unwrap the power cord and plug into an electrical outlet.





Step on the recline pedal to recline the unit for cleaning position.

Tips:

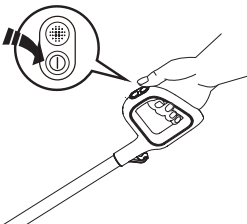
- Press the  button to turn on/off the voice prompt.
- Press the  button twice to switch languages. (More voice languages will be added, please refer to the actual product for now.)



Press the  button and the appliance will start in AUTO mode by default. Press it again to turn off the appliance. Switch between AUTO, MAX and DRY mode by pressing the  button.

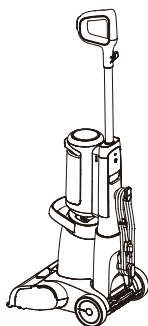

Stop Working

In AUTO/MAX/DRY mode, the appliance will stop working when put uprightly and start running again when you recline.

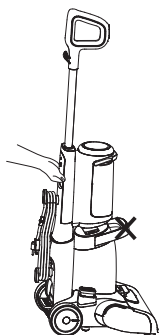

Do not grip DWT handle to lift or move the appliance.

Grip the back carry handle to lift or move appliance. Empty CWT and DWT after each use.

Note:

- The carpet cleaner differs from the traditional vacuum cleaner.
- In all modes, it blows hot air, whose temperature is 158-176°F (70-80°C).
* Appropriate temperature is conducive to dissolve the dirt and helps surfactant in the solution to decompose the dirt.
- In AUTO/MAX mode, it sprays water when moving forward and stops spraying when moving backward.
- Take a spot test on a small and marginal area of the carpet for colorfastness. Gently rub surface with a damp white cloth. Then wait ten minutes and check for color removal or bleed with a white paper towel.
- During use, don't keep the appliance at a resting position for a long time.

Preparing for Use (Accessory Hose & 2 in 1 Nozzle)

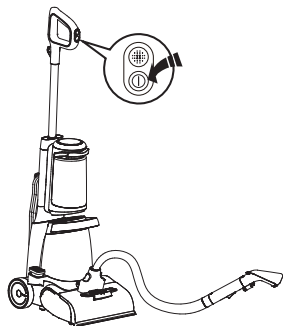

Attach the accessory hose, stand the appliance upright and ensure that it is power on (if not, press the  button), the appliance will enter in ACCESSORY mode, the appliance will stop working when you recline.

Note:

Do not vacuum foamed liquid.

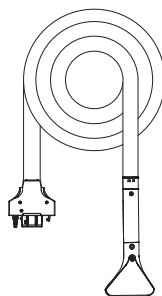

Store the accessories in the bag after use.

Cleaning Mode Selection

AUTO Mode

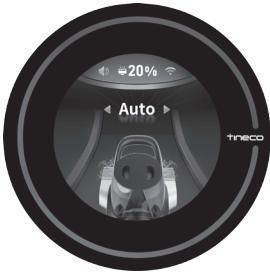

- In AUTO mode, the iLoop sensor automatically detects how dirty the carpet is and applies the appropriate volume of water spray.
- A red dirt monitoring loop indicates more dirt is detected, and a blue loop indicates less dirt is detected. This mode automatically provides the best cleaning solution.

MAX Mode



- In AUTO mode, press the  button to enter MAX mode.
- The iLoop only displays the dirty amount, and the spray volume keeps at the maximum of "100".

DRY Mode



- In MAX mode, press the  button to enter DRY mode.
- Press the  button to switch to AUTO mode.

ACCESSORY Mode

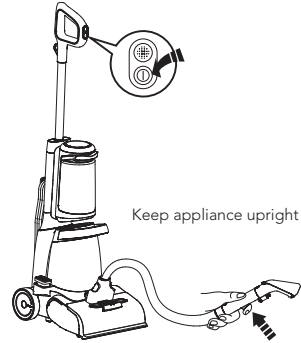

- Ensure the appliance is power on (if not, press the  button), the appliance will enter into ACCESSORY mode. Press and hold the button on the 2 in 1 Nozzle to spray water, and release the button to stop.
- In ACCESSORY mode, the spray volume keeps at the maximum of "100".
- Stand the appliance upright, remove the accessory hose, the appliance will enter in AUTO mode.

Note:

Keep sharp objects away from the digital display screen to avoid scratches and scrapes.

App

All the functions can be performed using the Tineco app. Download the Tineco app from the App Store, Google Play and Tineco Official Site.

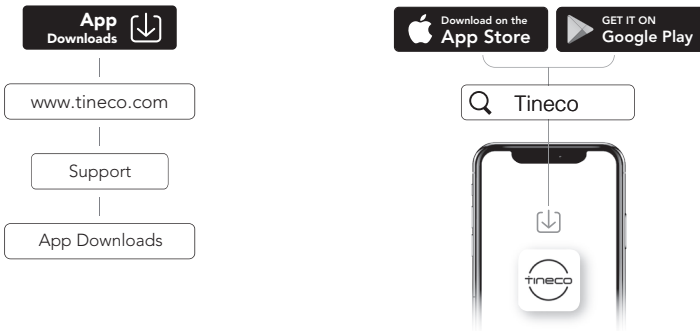

Note:

The default setting for voice prompt is English, you can set other languages via App.

Voice Prompt (Contents may vary, please in kind prevail.)

Status	Reminder
Guide for Carpet One Pro	Quick start guide
	Maintenance tips
	Network connection guide
	Handle dismantling guide
	Accessory use guide
Connect to the appliance	Scan the QR code to download the app and connect the appliance
WiFi network connected	Network connected.
WiFi network disconnected	Connection canceled
Unable to connect WiFi	Stand the appliance upright before connecting
Voice prompts on	Voice prompts on
Voice prompts disabled	Voice prompts disabled
Restore factory settings	Factory settings restored
AUTO mode by default	AUTO mode
Switch to MAX mode	MAX mode
Switch to DRY mode	DRY mode
Switch to ACCESSORY mode	ACCESSORY mode
Clean Water Tank is empty	Clean water tank empty, please refill water and cleaning solution
Clean the channel	Clean the channel under the dirty water tank
Dirty Water Tank is full	Dirty water tank full, please empty
Dirty Water Tank not installed correctly	Check the dirty water tank
Brush roller is tangled	Please clean the brush roller
Brush roller cover not installed	Please install the brush roller cover
Switch to other modes	Remove accessory before using other modes
Unable to use DRY mode	Remove accessory before using DRY mode
Unable to use ACCESSORY mode	Stand the appliance upright to operate ACCESSORY mode
Appliance is not upright	Stand the appliance upright
Accessory installed	Accessory installed
Accessory removed	Accessory removed
Shutting down	Shutting down
Power is off	Power off, please clean the dirty water tank
Update firmware	Firmware updated

Maintenance

IMPORTANT! Always switch off the cleaner and remove the power plug from the electricity power supply before cleaning your appliance, when not in use or attempting any maintenance task.

Note:

- For optimal performance and to prevent odors, always **clean** and **dry** DWT, filters, brush roller, brush roller cover, 2 in 1 nozzle **completely** after each use.
- Please make sure each part is installed correctly or the appliance may not work properly.
- After maintenance, place the appliance vertically. Do not expose the appliance to direct sunlight, and store it indoors in a dry place.

Main Body

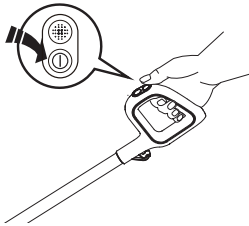

To reduce the risk of injury, switch off before performing maintenance.



Use a cloth to clean the surface with a neutral detergent. The cloth should be dry to prevent water from entering the appliance.

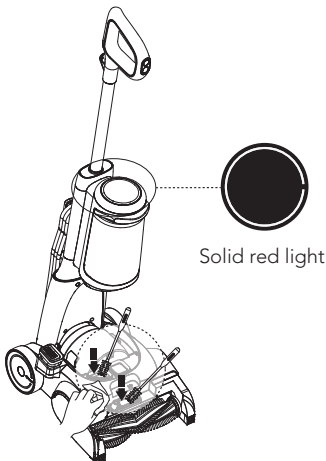

When LED loop illuminates red, remove Dirty Water Tank, clean the dirt sensor with a damp cloth or the cleaning tool.

Dirty Water Tank

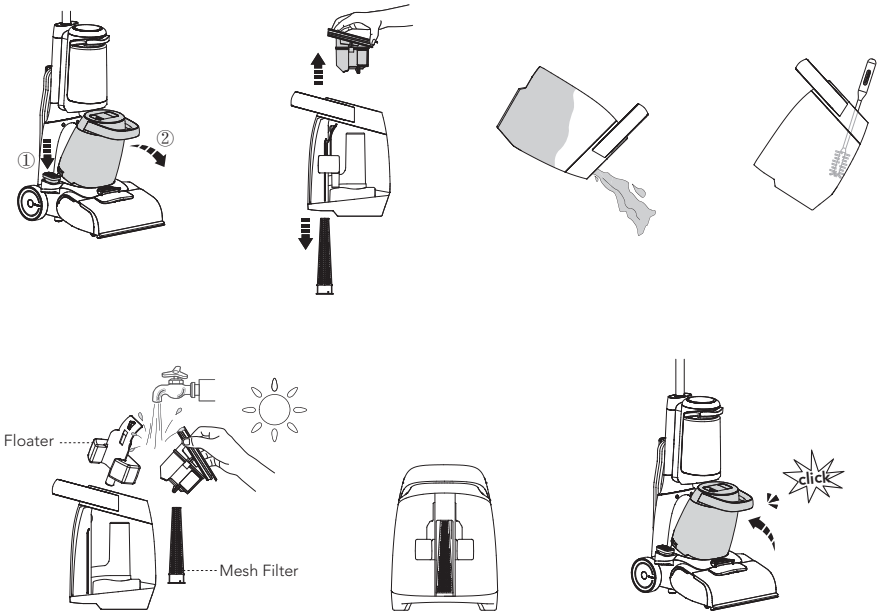

- When dirty water reaches the Max line, the appliance will stop working and show a reminder on the display and play a voice prompt.
- Step on the recline pedal and press the DWT handle to remove it.
- Pull up the tank lid and mesh filter to empty the DWT. Use the cleaning tool to remove remaining debris. Rinse the inside of the DWT & tank lid & floater & mesh filter and place back into the appliance.

Note:

Check if the floater is in good condition and press it to the bottom.

Sponge Filter

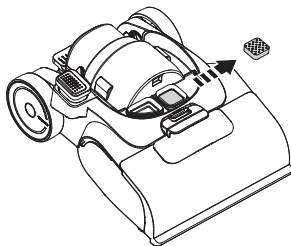

Remove the DWT, take the filter out and wash it after each use.

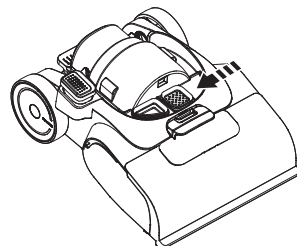

Reinstall.

Brush Roller Cover

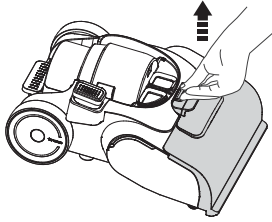

Press brush roller cover release button on the cover and pull upward to remove.

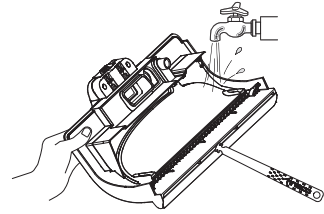

Rinse with water. Use the provided cover scraper to clean the gap in the front side.

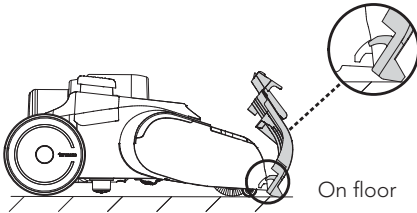

On floor

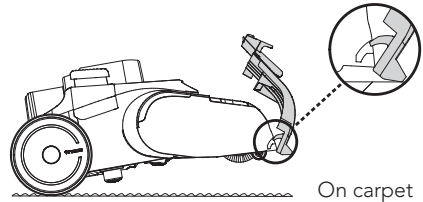

On carpet

When replacing, always latch the brush cover into place to avoid leakage.

Brush Roller

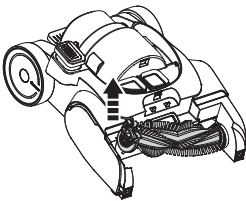

Remove the brush roller by squeeze the brush roller tab and pulling out.

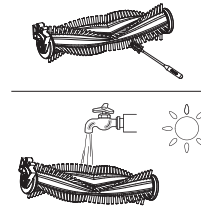

Using the cleaning tool, remove the hair and debris wrapped around the roller and rinse with water. Allow it to dry completely before reinstalling.

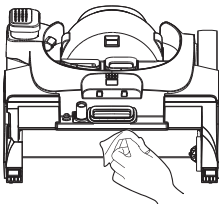

Remove hair and debris from the brush roller chamber and the opening with a tissue or a damp cloth.

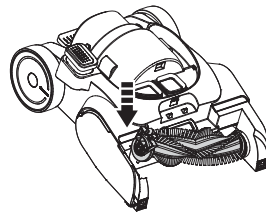

Replace the brush roller by inserting the brush roller end into the right side of the holder, then attach the roller tab to the left side to lock into place.

Accessory Hose & 2 in 1 Nozzle

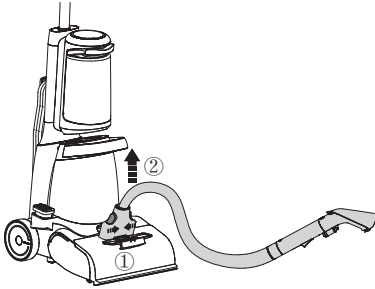

Press the buttons on both sides to remove the hose.

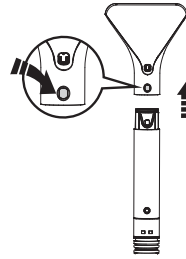

Press the release button to remove the accessory brush.

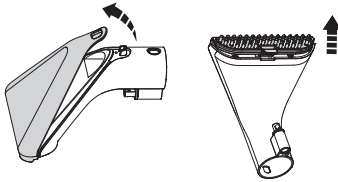

Remove the top cover and brush head.

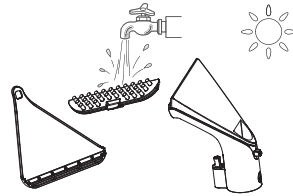

Rinse with water. Allow it to dry completely before reinstalling.

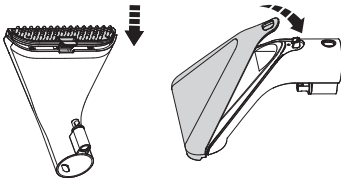





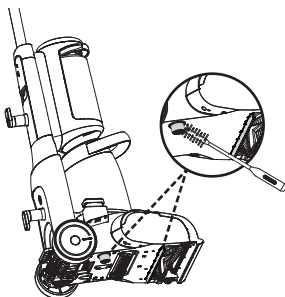



Reinstall.

Humidity Sensor



Clean the humidity sensor after each use, rotate the sensor several times or use the cleaning tool. Also clean the bristle after each use.

Troubleshooting

Problem	Possible cause	Solution
The appliance does not turn on	The power cord is not plugged in, or the socket is not energized	Ensure that the socket is energized and the power cord is plugged in
Weak suction	<ol style="list-style-type: none"> 1. The mesh filter is blocked 2. The sponge filter is blocked 3. The brush roller cover is not correctly installed 	<ol style="list-style-type: none"> 1. Clean the mesh filter 2. Remove blockages or replace the sponge filter 3. Install brush roller cover correctly
ACCESSORY mode abnormal in animation  Voice prompt: Stand the device upright	The appliance is tilted while installing accessory brushes	Stand the appliance upright, then enter the ACCESSORY mode
AUTO mode abnormal in animation  Voice prompt: Stand the device upright	The appliance is tilted while removing accessory brushes	Stand the appliance upright and tilt again to enter AUTO mode
Channel has a blockage in animation  Voice prompt: Clean the channel under the dirty water tank	<ol style="list-style-type: none"> 1. Dirt sensor malfunction or blocked 2. Channel has a blockage 3. Sponge filter is dirty 	<ol style="list-style-type: none"> 1. Remove blockages 2. Clean the debris channel 3. Clean the sponge filter
CWT empty in animation  Voice prompt: Please add clean water or solution to clean water tank	CWT is empty	Refill CWT
DWT full in animation  Voice prompt: <ol style="list-style-type: none"> 1. Dirty water tank full, please empty 2. Please check the dirty water tank 	<ol style="list-style-type: none"> 1. The dirty water in DWT has reached the MAX line 2. The floater is not installed correctly 3. Channel has a blockage 	<ol style="list-style-type: none"> 1. Empty the dirty water and then reinstall the DWT 2. Check if the floater is in good condition and press it to the bottom 3. Remove blockages
Brush roller tangled in animation  Voice prompt: Please clean the brush roller	The brush roller is blocked	Remove blockages
Brush roller cover uninstalled in animation  Voice prompt: Please install the brush roller cover	The brush roller cover is not installed	Install brush roller cover correctly
WiFi indicator with a slash 	WiFi is not connected	Follow the in-app guide to connect to WiFi
Pump malfunction in animation	Pump malfunction	Contact Customer Service
Humidity sensor malfunction in animation	Humidity sensor malfunction	Contact Customer Service

Note:

If the above troubleshooting guide fails to provide a solution, please contact Customer Service on customerservice@godfreys.com.au / customerservice@godfreys.co.nz or visit our website www.godfreys.com.au / www.godfreys.co.nz for further support.

Warranty

2-YEAR LIMITED WARRANTY

Your washer, in the case of domestic use, has a two year parts and labour warranty against product defects and failures when the product is used in accordance with the terms and conditions of this warranty statement.

This warranty is provided by Electrical Home-Aids Pty. Ltd. and commences from the original date of purchase and is not transferable; please retain your original proof of purchase for any warranty claims.

This warranty is valid only in the country where the washer is purchased.

The washer must be operated in accordance with these instructions and used only for domestic household cleaning. This washer is not fit to be used as an industrial washer, and is not designed for the collection of vitreous building material including particle board, construction products and similar products such as wood/ fibres, cement, fillers, fibre glass etc or excessive or frequent sand. The infrequent pick-up of these materials in these circumstances may be harmful to your washer and may void the warranty.

Accessories and consumables including filters, unless defective in manufacture are not subject to this warranty. In order to prolong the life of accessories and consumables, regular care and maintenance is recommended.

When properly used and cared for, your washer will render excellent service; refer to the instruction manual for further details, as misuse or failure to follow the instructions makes this warranty void.

In the event of service, claim or advice being needed, please contact: Electrical Home-Aids Pty. Ltd. Brandon Office Park, Building 3, First Floor, 530-540 Springvale Road, Glen Waverley VIC, 3150, Australia 1800 815 270 (AUS) or 0800 282 288 (NZ) Monday-Friday 9am-5pm EST.

The decision to repair or replace the washer is at the sole discretion of Electrical Home-Aids Pty Ltd. Electrical Home-Aids Pty Ltd decide to repair or replace the washer, it will do so at its own cost. Electrical Home-Aids Pty Ltd is unable to accept responsibility under this warranty for any repair work not carried out by an authorised Service Agent or from the use of non-genuine parts. If any part is no longer available or manufactured, Electrical Home-Aids Pty Ltd will replace it with a genuine functional replacement part.

This warranty does not apply to the cost of replacing any parts of the product due to normal wear and tear, alterations, improper installation, physical abuse, misuse or accidental damage. Any transportation costs involved in the repair of defective parts shall be borne by the claimant.

If proof of purchase cannot be provided at the time of a warranty claim or service, any work carried out on the washer is chargeable. The repair of the washer under this warranty does not extend the original period of warranty.

The benefits conferred by this warranty are in addition to all other rights and remedies in respect of the product as outlined under the Competition and Consumer Act and other State and Territory laws.

“Our goods come with guarantees that cannot be excluded under the Australian Consumer Law. You are entitled to a replacement or refund for a major failure and compensation for any other reasonably foreseeable loss or damage. You are also entitled to have the goods repaired or replaced if the goods fail to be of acceptable quality and the failure does not amount to a major failure.”

WARRANTY SERVICE

Register: We highly recommend that upon purchase, you register your appliance on the Tineco official website (www.tineco.com) and enjoy exclusive benefits. To register, please enter the whole serial number (find it on the back of the appliance).

Failure to register your product won't diminish your warranty rights.

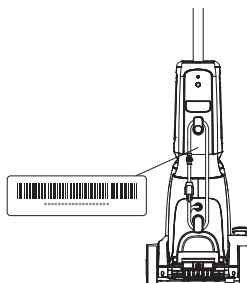

Call our Customer Service:

AUS: 1800 815 270

NZ: 0800 282 288

Or email our Customer Service:

customerservice@godfreys.com.au

customerservice@godfreys.co.nz

Visit Official Website:

www.godfreys.com.au

www.godfreys.co.nz

tineco
Live Easy.
Enjoy Life.



tinecoglobal 

Tineco Official Site: www.tineco.com

Customer Support & Service Hotline

AUS: 1800 815 270

NZ: 0800 282 288

www.godfreys.com.au

www.godfreys.co.nz

Distributed in Australia & New Zealand, by Electrical Home AIDS Pty Ltd (Godfreys)
Brandon Office Park, Building 3, First Floor 530-540 Springvale Road, Glen Waverley VIC 3150 Australia.